

INSTALLATION NOTES

Curaflex® pipe sleeves with fixed and loose flange

- Curaflex® 6000
- Curaflex® 5000
- Curaflex® 6.6002
- Curaflex® 5.5002
- Curaflex® 6.6000/U

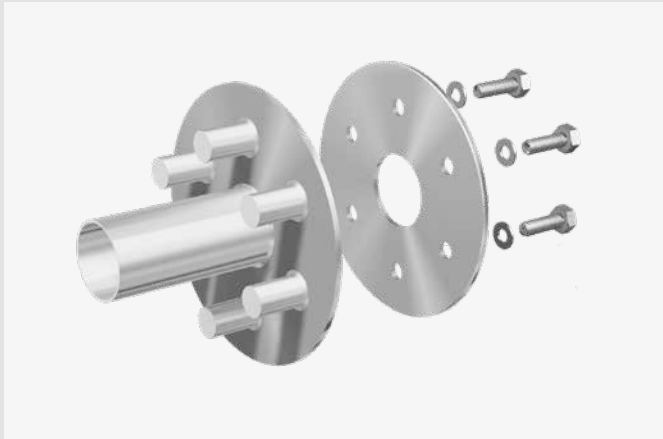

Curaflex® 6000

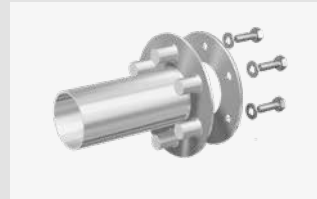

Curaflex® 5000

Dear Customer,

Thank you for choosing a quality product from our range.

Please read this message and the included installation instructions in full before installing or processing our products and keep both in a safe place after installation.

Safety instructions:

- Our products may only be installed by persons with the necessary specialist knowledge.
- For your own protection and the protection of third parties, the work area and any necessary pipe trenches must be properly constructed and secured in accordance with the applicable regulations.
- When installing our sealing and fire protection systems, the recognised rules of technology, the relevant regulations of the employers' liability insurance associations, the VDE regulations and the applicable safety and accident regulations must be observed. Parts of the body may be crushed or other serious injuries may occur when tensioning or fixing the products in place.
- The safety data sheets must be observed.
- Check that the delivered product is complete (the scope of delivery is listed separately in the installation instructions) and check all individual parts for any damage. Only undamaged parts may be installed.
- Check that the product is suitable for its intended use using the installation instructions. If there are any particular demands,

please clarify the use of the product with us in advance. Request our checklists for this purpose or download them from www.doyma.com.

Any liability on our part is excluded for misuse!

- Finally, please observe the instructions for the tools and equipment required for installation.

Industrial property rights:

- Our industrial property rights and those of third parties must be observed.

Disposal:

- Please observe the applicable regulations when disposing of components, accessories and packaging.

Terms and conditions of sale:

- The current version of our terms and conditions of sale and delivery shall prevail.

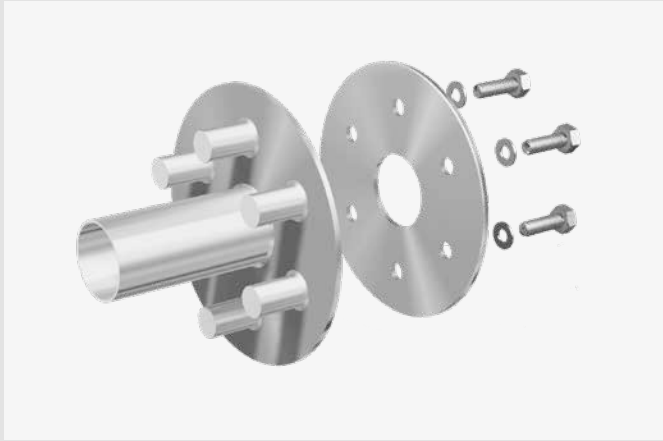

Curaflex® 6000

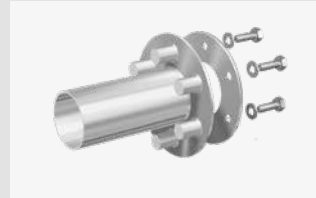

Curaflex® 5000

Intended purpose

Pipe sleeve for buildings with tanking membranes and thick coatings (black tank) according to DIN 18533/DIN 18535; for installation in walls, ceilings and floor slabs/floors.

Curaflex® 5000 and 6000:

Steel pipe sleeve with fixed and loose flange and watertight welded threaded sleeves.

Curaflex® 5.5002 and 6.6002:

Specially manufactured steel pipe sleeve with integrated fixed and loose flange (with threaded bolt; loose flange split) and additional bonding/mounting flange. Ideal for insulated structures.

Curaflex® 6000, 6.6000/U:

Specially manufactured steel pipe sleeve with integrated fixed flange (with threaded bolts) and split loose flange. Ideal for floor slab penetrations with sealing membrane on the pressure side ("water side").

Curaflex® 5000, 5.5002:

Application for non-pressing water.

Curaflex® 6000, 6.6002, 6.6000/U:

Application for pressing water.

Please note:

- Building services duct systems are not secure points or support bearings, but are used exclusively for elastic sealing of pipes and cables.
- Slight axial movements of the pipes are permitted.
- To seal the annular space between pipe/cable and pipe sleeve, you will need a sealing element. We recommend installing a Curaflex® gasket insert.

Attention:

After embedding in concrete, tighten the gasket insert with the specified torque. If the pipe has already been laid, the pipe sleeve (for all types named in this document) must be positioned centrally around the pipe and fixed in place before embedding in concrete.

Scope of delivery

- Curaflex® pipe sleeve (when using a "thick coating" in sanded version)
- If a "thick coating" is used, additional glass fibre matting, spacers, rubber seals
- Installation notes

Accessories (optional)

Curaflex® 1775 packings
Curaflex® 1701 formwork holders
Curaflex® 1702 sealing plugs
Gasket insert: Curaflex® or Curaflex® Nova

Further accessories available upon request.

- Curaflex® 6000
- Curaflex® 5000
- Curaflex® 6.6002
- Curaflex® 5.5002
- Curaflex® 6.6000/U

Installation conditions

The fixed and loose flange must be clean and free of dust and grease. Distances for flange constructions in accordance with DIN 18533 must generally be arranged as follows:
 Flange edge to flange edge or to other components, e.g. building edges and channels, wall connections, not less than 150 mm

for non-pressing water and not less than 300 mm for pressing water. For expansion joints, distances of at least 300 mm must be maintained for non-pressing water and at least 500 mm for pressing water, unless a greater distance is required for processing reasons.

Installation steps

Curaflex® 5000, 6000, 5.5002, 6.6002, 6.6000/U

Curaflex® 5000, 6000

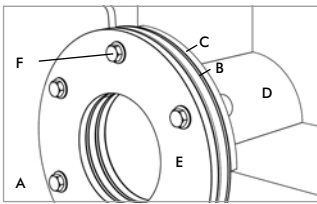

Tanking membrane (A), packings (B), fixed flange (C), pipe sleeve (D), loose flange (E), fastening for loose flange (F)

Curaflex® 5.5002

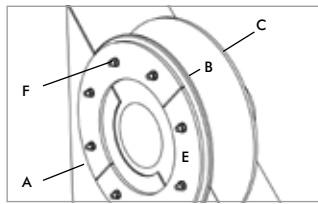

For installation on roofs with insulation. Tanking membrane (A), fixed flange (B), additional bonding/mounting flange (C), loose flange (E), fastening for loose flange (F) Note: packings like Curaflex® 5000 illustration, etc.

Curaflex® 6.6002

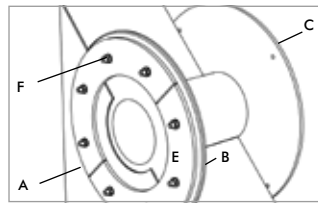

For installation in front of a thermal insulated wall. Tanking membrane (A), fixed flange (B), additional bonding/mounting flange (C), loose flange (E), fastening for loose flange (F) Note: packings like Curaflex® 5000 illustration, etc.

Curaflex® 6.6000/U

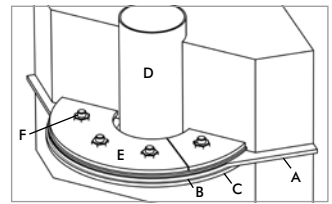

For installation in a floor slab Tanking membrane (A), packings (B), fixed flange (C), pipe sleeve (D), loose flange (E), fastening for loose flange (F)

1

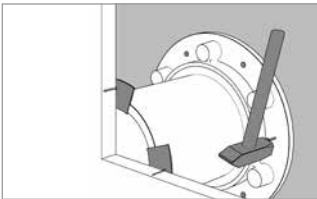

Installation on flange side through drilled holes in fixed flange. Fasten the pipe sleeve side with Curaflex® 1701 formwork support (not included in the scope of delivery).

2 optional

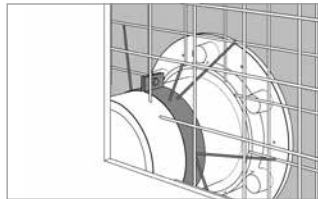

Fastening in steel formwork by welded connections with pipe clamp (not included in the scope of delivery).

3

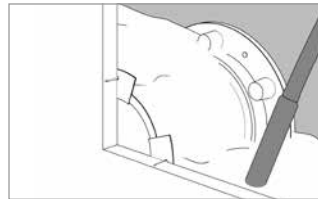

Compact the concrete around the pipe sleeve well.

4

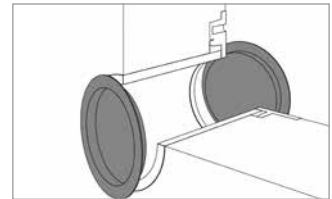

Protect the pipe sleeve during the raw construction phase with Curaflex® 1702 sealing plug (not included in the scope of delivery).

- Curaflex® 6000
- Curaflex® 5000
- Curaflex® 6.6002
- Curaflex® 5.5002
- Curaflex® 6.6000/U

For tanking membranes

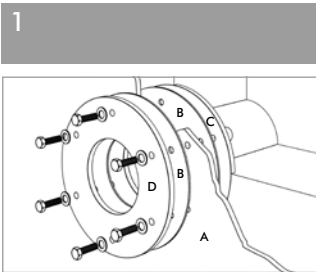

Cut the tanking membrane (A) and necessary packings* (B), if any, for loosely laid membranes in accordance with the membrane manufacturer's specifications (use loose flange as template). Position the packings and membrane on the fixed flange (C). When cutting the membrane, ensure that its surface is not damaged in the process. Use a punch to create the holes for the bolts (M12 = 16 mm, M20 = 24 mm). Place loose flange (D) with the face towards the packing/tanking membrane. Mount the washers and nuts.

Important: the membrane must not have any kinks, folds, bumps, sticky points or similar in the area around the fixed and loose flange.

*Elastomer packings (according to DIN 18533) for plastic tanking membranes are available as accessories.

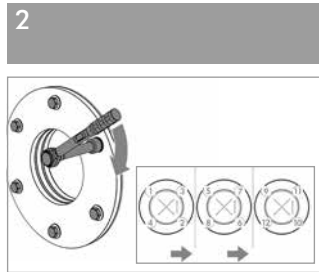

Tighten the nuts several times crosswise. For torques, see the table on the back (extract from DIN 18533 or according to the membrane manufacturer's specifications).

For thick coatings

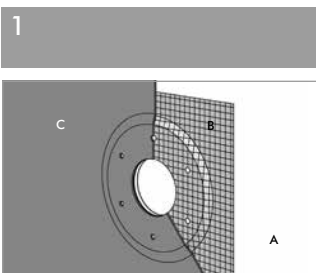

Apply the first layer of KMB thick coating (A) to the surface to be sealed and to the sanded fixed flange (KMB = plastic-modified thick coatings). In doing so, observe the guidelines for processing KMB. Insert fleece/reinforcing insert (B) and press lightly into the thick coating. Apply second layer of KMB (C).

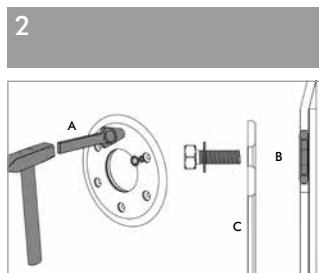

Punch out KMB after drying using a punch tool (A) centrally around the pins (Ø 40 mm for M12, Ø 55 mm for M20). Insert spacers and O-rings (B). Place both halves of the loose flange (C) with the face or sanded surface towards KMB. Mount the washers and nuts.

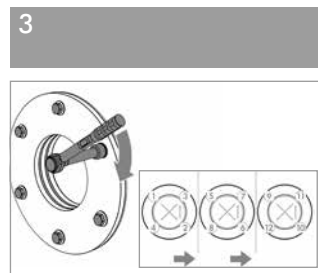

Tighten the nuts several times crosswise. For torques, see the table on the back (extract from DIN 18533 or according to the membrane manufacturer's specifications).

For fresh concrete bonded waterproofing membranes

Fresh concrete bonded waterproofing membranes are not regulated by DIN 18533. The DAfStb (German Committee for Reinforced Concrete) guideline – ‘Wasserundurchlässige Bauwerke aus Beton’ [Waterproof concrete structures] (Waterproofing guideline) and DIN 1045 provide for additional measures, particularly with regard to usage class A, and do not preclude sealing in the composite. As a result, the use of fresh concrete bonded waterproofing membranes in both areas of application requires the consent of the client and is subject to compliance with building regulations

and must be carried out in accordance with the specifications of the applicable general building inspection certificate for the respective seal.

DOYMA Curaflex sealing systems are tested for use with the fresh concrete composite systems SikaProof A (Sika Deutschland GmbH) and Preprufe (GCP Germany GmbH). The contents of the tests are contained in the corresponding test reports.

The test reports can be downloaded from the download centre at www.doyma.com.

Fresh concrete composite systems with fleece lamination

Lay the fresh concrete bonded waterproofing membrane in accordance with the specifications of the membrane manufacturer and fasten it to the formwork.

Marking of the penetration, bolts and external dimensions of the fixed flange on the fresh concrete bonded waterproofing membrane.

Use a punch to create the holes for the bolts (M12 = 16 mm, M20 = 24 mm).

In the area of the flange connection, the swelling paste must be applied to the fleece lamination on the side of the fresh concrete bonded waterproofing membrane facing the concrete.

Attach the first EPDM packing* to the fixed flange and attach the fixed flange to the formwork with 20 Nm.

Concreting of the component and stripping after the concrete has cured.

Place the second EPDM packing on the loose flange and screw the loose flange to the fixed flange. Tighten the nuts several times crosswise. The nuts must be tightened after the swelling paste has dried for at least one week. Torques must be carried out according to the specifications of the membrane manufacturer or the specifications of the respective test report (SikaProof A with 80 Nm).

Fresh concrete composite systems with adhesive layer

Lay the fresh concrete bonded waterproofing membrane in accordance with the specifications of the membrane manufacturer and fasten it to the formwork.

Marking of the penetration, bolts and external dimensions of the fixed flange on the fresh concrete bonded waterproofing membrane.

Use a punch to create the holes for the bolts (M12 = 16 mm, M20 = 24 mm).

Attach the first EPDM packing* to the fixed flange and attach the fixed flange to the formwork with 20 Nm.

Concreting of the component and stripping after the concrete has cured.

Place the second EPDM packing on the loose flange and screw the loose flange to the fixed flange. Tighten the nuts several times crosswise. Torques must be carried out according to the specifications of the membrane manufacturer or the specifications of the respective test report (SikaProof A+, SikaProof P, Preprufe 160R-300R and Preprufe 800PA with 80 Nm).

Instructions

When cutting the fresh concrete bonded waterproofing membrane, care must be taken to ensure that its surface is not damaged.

Important: The fresh concrete bonded waterproofing membrane must not have any kinks, folds, bumps, sticky points or similar in the area around the fixed and loose flange.

* EPDM packings for fresh concrete bonded waterproofing membrane are available as accessories

- Curaflex® 6000
- Curaflex® 5000
- Curaflex® 6.6002
- Curaflex® 5.5002
- Curaflex® 6.6000/U

**Guide torque values of the membrane manufacturers
or DIN 18533 for tightening the loose flange**

Type of tanking membrane or thick coating	Torques for M 12 (Nm) Width across flats 19 mm	Torques for M 20 (Nm) Width across flats 30 mm
When using DOYMA Curaflex® 1775 packings for tanking membranes	30	80
For KMB (plastic-modified thick coatings) in combination with DOYMA Curaflex® 1776 accessories	30	100
Bare bitumen membranes according to DIN 52129-R 500	12*	50*
PIB according to DIN 18533-2:2017-06, table 3, line 2	12*	50*
Bitumen and polymer-bitumen membranes according to DIN 18533-2:2017-06, table 1, with reinforcement made of polyester fleece, KTP or copper tape inlay	15*	65*
Bitumen and polymer bitumen membranes according to DIN 18533-2:2017-06, table 1, with reinforcement made of glass fabric or KTP	20*	80*
Bare bitumen membrane DIN 52129 – R 500 N + 1 x †	20*	1st tightening: 100* 2nd and 3rd tightening: 80*
Bitumen-compatible plastic and elastomer membranes according to DIN 18533-2: 2017-06, table 3, excluding line 2	20*	80*
Bare bitumen membrane DIN 52129 – R 500 N + 2 x †	30*	1st tightening: 120* 2nd tightening: 100* 3rd tightening: 80*
Plastic or elastomer membranes according to DIN 18533-2: 2015-12, table 3, loosely laid FLK according to ETAG 005	30*	100*
Elastomer clamp joint tapes – for smooth clamping surface – for ribbed clamping surface with packing of uncured raw rubber, 100 mm wide, not older than 90 days	40* –	165* 165*

* Torques from DIN 18533-1

INSTALLATION NOTES
Curaflex® pipe sleeves
with fixed and loose flange

- Curaflex® 6000
- Curaflex® 5000
- Curaflex® 6.6002
- Curaflex® 5.5002
- Curaflex® 6.6000/U

25
years
guarantee

INSTALLATION NOTES
**Curaflex® pipe sleeves
with fixed and loose flange**

- Curaflex® 6000
- Curaflex® 5000
- Curaflex® 6.6002
- Curaflex® 5.5002
- Curaflex® 6.6000/U

DOYMA products are continuously being further developed. Technical changes will be performed without prior notice.
25 year warranty on all DOYMA products. **More information at www.doyma.com**

DOYMA GmbH & Co

SEALING SYSTEMS
FIRE PROTECTION SYSTEMS

Industriestr. 43-57
28876 Oyten

Phone: 0 42 07/91 66-300
Fax: 0 42 07/91 66-199

www.doyma.de
info@doyma.de

25
years
guarantee

