

Dokument-Nr.:	332514-02/08.2025
Gedruckt nach:	-----
Größe (BxH):	148 x 210 mm
Farbigkeit:	1/1-farbig (Euroskala)
Dateipfad:	EBA_QS_Nova_R1-R4_DE_EN_FR_NL_082025

English

INSTALLATION NOTES

Quadro-Sicura®
HOUSE LEAD-INS



- Quadro-Sicura® Nova R1
- Quadro-Sicura® Nova R2
- Quadro-Sicura® Nova R3
- Quadro-Sicura® Nova R4

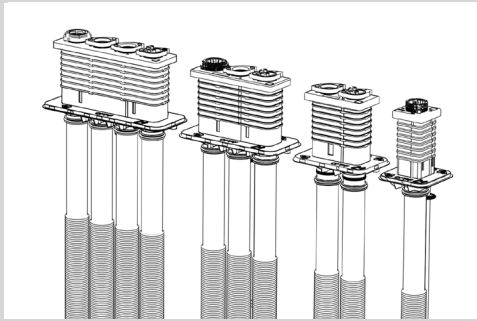

Quadro-Sicura® Nova R4, Quadro-Sicura® Nova R3,
Quadro-Sicura® Nova R2, Quadro-Sicura® Nova R1

Dear Customer,

Thank you for choosing a quality product from our range.

Please read this message and the included installation instructions in full before installing or processing our products and keep both in a safe place after installation.

Safety instructions:

- Our products may only be installed by persons with the necessary specialist knowledge.
- For your own protection and the protection of third parties, the work area and pipe trenches must be properly constructed and secured in accordance with the applicable regulations.
- When installing the sealing system, the recognised rules of technology, the relevant regulations of the employers' liability insurance associations, the VDE regulations and the applicable safety and accident regulations must be observed. Parts of the body may be crushed or other serious injuries may occur when tensioning or fixing the products in place.
- The safety data sheets must be observed.

25
years
guarantee



INSTALLATION NOTES

Quadro-Secura® house lead-ins

- Quadro-Secura® Nova R1
- Quadro-Secura® Nova R2
- Quadro-Secura® Nova R3
- Quadro-Secura® Nova R4

25
years
guarantee

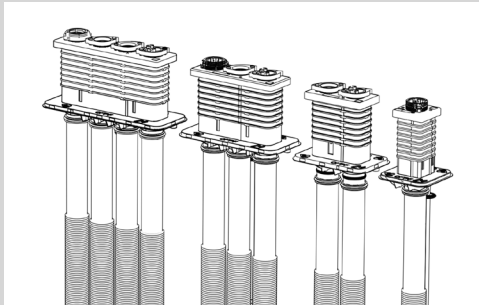

Quadro-Secura® Nova R4, Quadro-Secura® Nova R3,
Quadro-Secura® Nova R2, Quadro-Secura® Nova R1

- Check that the delivered product is complete (the scope of delivery is listed separately in the installation instructions) and check all individual parts for any damage. Only undamaged parts may be installed.
- Check that the product is suitable for its intended use using the installation instructions. If there are any particular demands, please clarify the use of the product with us in advance. Request our checklists for this purpose or download them from www.doyma.com.

Any liability on our part is excluded for misuse!

- Finally, please observe the instructions for the tools and equipment required for installation.

Industrial property rights:

- Our industrial property rights and those of third parties must be observed. In all other respects, our Terms and Conditions of Sale and Delivery shall apply.

Disposal:

- Please observe the applicable regulations when disposing of components, accessories and packaging.

Terms and conditions of sale:

- The current version of our terms and conditions of sale and delivery shall prevail.

INSTALLATION NOTES

Quadro-Sicura® house lead-ins

- Quadro-Sicura® Nova R1
- Quadro-Sicura® Nova R2
- Quadro-Sicura® Nova R3
- Quadro-Sicura® Nova R4

25
years
guarantee

General information and intended use

The single- and multi-compartment house lead-in Quadro-Sicura® Nova R1, R2, R3 and R4 for buildings without basement consists of cast-in part Quadro-Sicura® Nova R1-R, R2-R, R3-R and R4-R and from the installation part Quadro-Sicura® Nova R1-I, R2-I, R3-I and R4-I.

General notes



- The single- and multi-compartment house lead-ins comply with supplement B1 of the test specification VP 601 of January 2008 and are compatible with gas house lead-in that also comply with supplement B1 in terms of design and construction.
- Depending on the foundation design, a recess must be provided in the strip foundation after consultation with the architect or building contractor in order to maintain the wall distance!

Safety instructions



- The bend-resistant jacket pips must be stored in such a way that they are not exposed to very low temperatures ($< 5\text{ °C}$) or high temperatures ($>30\text{ °C}$), nor to direct sunlight. Storage must be tension-free, i.e. without pressure, tension, or comparable stress. Tension can lead to deformation or cracking.
- Protect the wall bushing from damage, moisture and contamination during installation. Check the delivery for completeness and all individual parts for possible damage. Only undamaged parts may be installed.

Description Quadro-Sicura® Nova R1, R2, R3 and R4

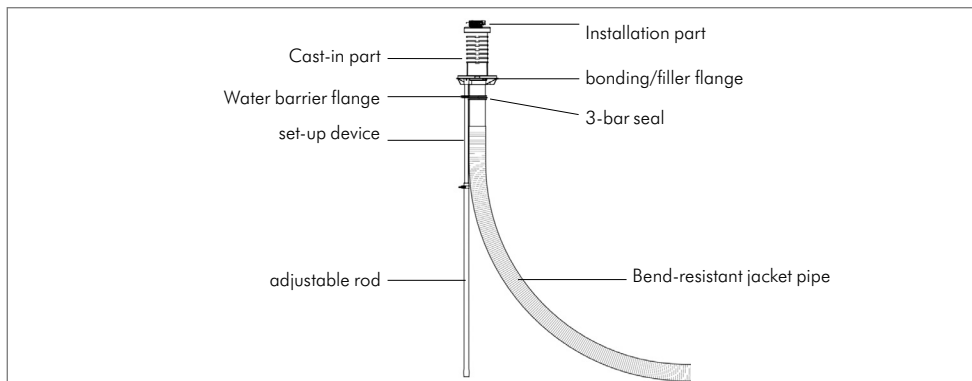

INSTALLATION NOTES

Quadro-Secura® house lead-ins

- Quadro-Secura® Nova R1
- Quadro-Secura® Nova R2
- Quadro-Secura® Nova R3
- Quadro-Secura® Nova R4

25
years
guarantee

Scope of delivery

The scope of delivery of the single- and multi-compartment house lead-in includes:

- 1 cast-in part including:
 - 7 cast-in part frames (black)
 - 1 cover incl. dragonfly
 - 1-4 bend-resistant jacket pipes
 - 1 set-up device with adjustable rod
- 1 installation part (for the building service seals water, electricity or telecom)

Required tools and equipment

To install the single- and multi-compartment house lead-in correctly, you will need the following tools and equipment in addition to the usual standard tool:

- Spirit level
- Pliers
- Hammer
- Yardstick
- Lubricant
- Self-volatilising lubricant

INSTALLATION NOTES

Quadro-Secura® house lead-ins

- Quadro-Secura® Nova R1
- Quadro-Secura® Nova R2
- Quadro-Secura® Nova R3
- Quadro-Secura® Nova R4

25
years
guarantee

Dimensions: cast-in part

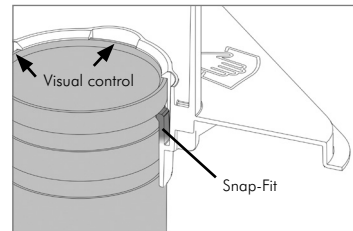
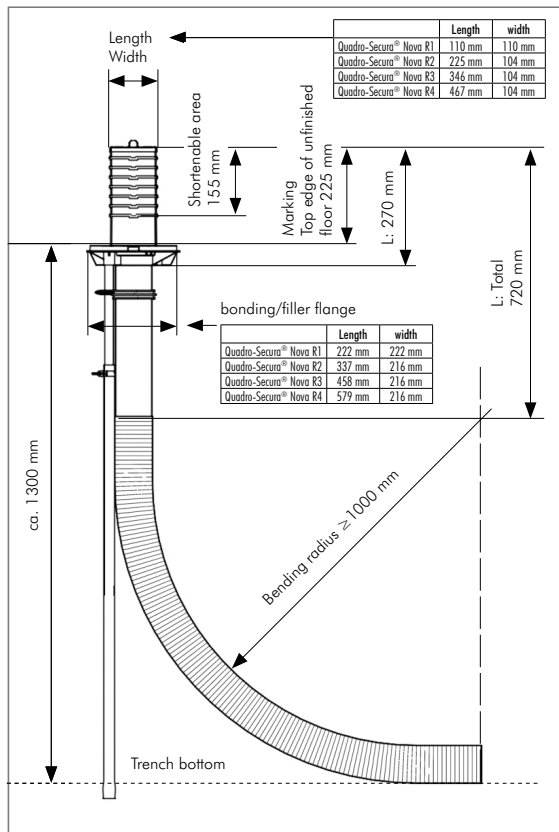

Installation advantage visual control

Snap-Fit enables the jacket pipes to be securely snapped into the into the cast-in part.

Placement of the cast-in part

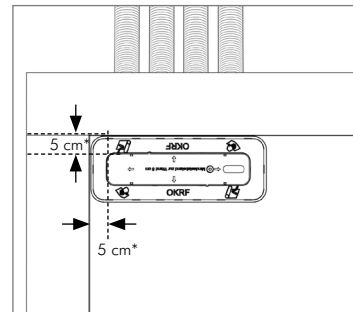

* Please coordinate the exact dimensions with your utility company.

INSTALLATION NOTES

Quadro-Sicura® house lead-ins

- Quadro-Sicura® Nova R1
- Quadro-Sicura® Nova R2
- Quadro-Sicura® Nova R3
- Quadro-Sicura® Nova R4

25
years
guarantee

The installation is described using the Quadro-Sicura® Nova R4 as an example.

2 Montage: Quadro-Sicura® Nova R4-R (cast-in part) preparation



For the exact positioning of the Quadro-Sicura® Nova R4-R (cast-in part), a sectional framework must be prepared on site. Ideally, the cord also marks the top of the unfinished floor.

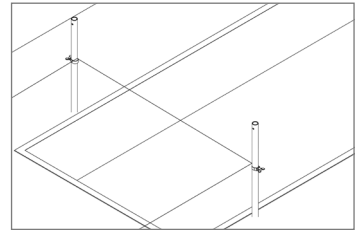

For the construction of concrete floor slabs, a minimum thickness of 200 mm must be provided in accordance with the WU guideline (water impermeable). For floor panels that are not manufactured in this quality, a minimum thickness of 130 mm is required by design in order to ensure sufficient concrete cover of the 3-bar seal set in concrete. Quadro-Sicura® Nova R4-R (cast-in part) and set-up device are plugged together and fixed with the wing screw.

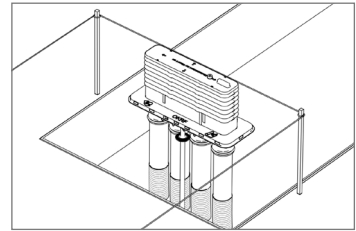

2.1 Aligning the set-up device

Align and position Quadro-Sicura® Nova R4-R (cast-in part) longitudinally with the set-up device from the position on the sectional framework. Use the spirit level on the cover to align the cast-in part horizontally and press it into the ground.

The exact height is not yet important.



- Observe the recommended wall distance of 5 cm.
- The unfinished part must not be covered later by the interior walls (unfinished wall + plaster).
- The arrangement of the internal pipes should be parallel to the sides of the wall.
- When positioning the multi-compartment house lead-in, ensure that the set-up device does not obstruct the empty pipe route (bend-resistant jacket pipe/cable protection pipes).
- Before installation, consult with the utility company regarding the distance.

INSTALLATION NOTES
Quadro-Sicura® house lead-ins

- Quadro-Sicura® Nova R1
- Quadro-Sicura® Nova R2
- Quadro-Sicura® Nova R3
- Quadro-Sicura® Nova R4

25
years
guarantee

2.2 Preparation of the adjustable rod

Then loosen the wing screw, hold the adjustable rod and pull off the Quadro-Sicura® Nova R4-R shell. Insert the supplied drive-in screw into the adjustable rod and fix it with the wing screw.

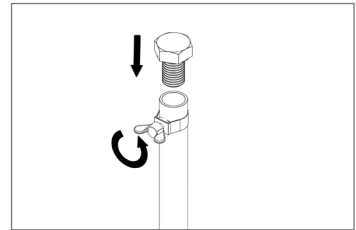

2.3 Hitting the adjustable rod

Hit the adjustable rod approx. 300 mm or until it is sufficiently into the ground until it is sufficiently fixed. Remove the drive-in screw again.

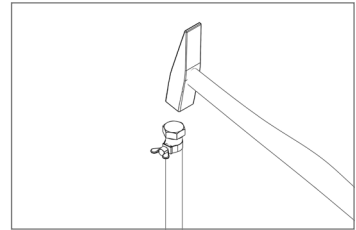

2.4 2.4 Positioning the cast-in part

Place the Quadro-Sicura® Nova R4-R (cast-in part) upside down on a surface such as a pallet.

This protects the dragonfly and the handle on the closing lid from damage.

Insert the set-up device into the opening provided for it.

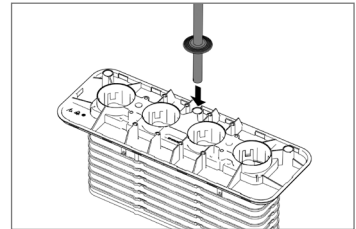

2.5 Mount jacket pipes

Insert the jacket pipes with the pipe end one after the other into the openings provided.

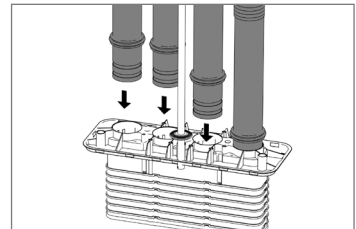

INSTALLATION NOTES

Quadro-Sicura® house lead-ins

- Quadro-Sicura® Nova R1
- Quadro-Sicura® Nova R2
- Quadro-Sicura® Nova R3
- Quadro-Sicura® Nova R4

25
years
guarantee

2.6 Detailed view

The jacket pipe audibly engages!

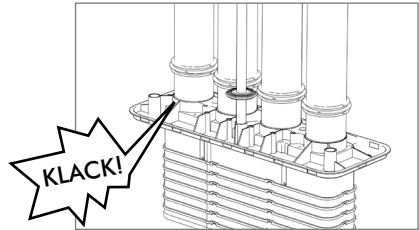

2.7 Interim result

Quadro-Sicura® Nova R4-R (cast-in part) with attached jacket pipes.

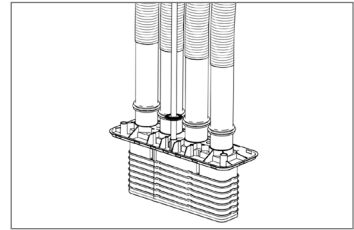

2.8 Visual inspection

The jacket pipe is correctly engaged (snap-fit), if the upper edge of the sleeve tube is in contact with the stop surface.

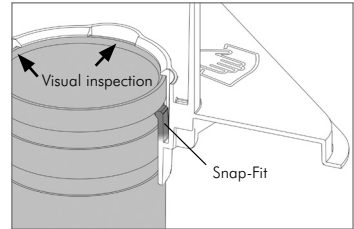

2.9 Place the cast-in part on the adjustable rod

Quadro-Sicura® Nova R4-R (cast-in part) with the jacket pipe attached to the hammered-in adjustable rod.

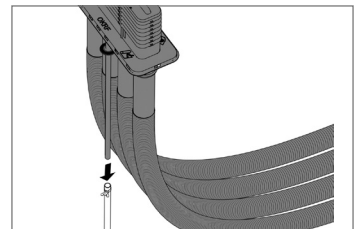

2.10 Alignment to the raw floor

Then align the Quadro-Sicura® Nova R4-R (cast-in part) in height to the uraw floor level. After adjusting the height, tighten the wing screw. This fixes the structure in place.

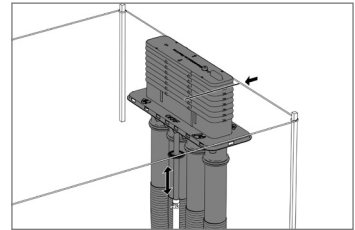

2.11 Observe the marking of the top edge

There is an identification/markung „OKRF“ on the Quadro-Sicura® Nova R4-R (cast-in part).

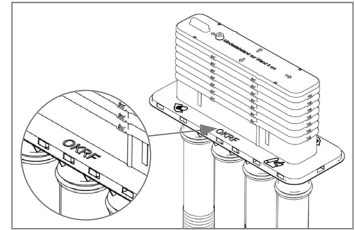

2.12 Carry out alignment

After the height has been fixed, the Quadro-Sicura® Nova R4-R (cast-in part) can be aligned in position with the aid of the existing dragonfly on the cover.

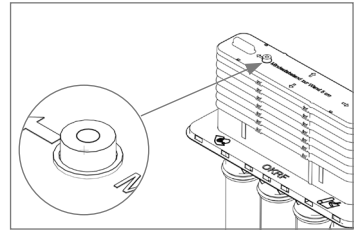

- For finished floor constructions larger than 225 mm, the use of an extension set is required. This is available as an accessory, please contact us.



- After connection of the pipes, compliance with the bending radii $R \geq 1$ m must be checked.
- The set-up device supplied is only a temporary fixation. Only the immediate filling with sand up to the level of the clean layer results in a positionally stable positioning of the floor slab feed-through.



- During the backfilling process, check the distance to the sectional framework as well as the vertical. Check the vertical position of the component and adjust if necessary.

INSTALLATION NOTES

Quadro-Sicura® house lead-ins

- Quadro-Sicura® Nova R1
- Quadro-Sicura® Nova R2
- Quadro-Sicura® Nova R3
- Quadro-Sicura® Nova R4

25
years
guarantee

2.13 Interim result

Positionally stable Quadro-Sicura® Nova R4-R (cast-in part) mounted vertically, aligned with the sectional framework and backfilled with sand.

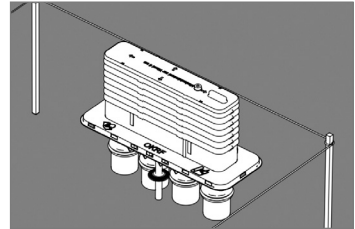

- Subsequent reworking is not necessary if the top edge of the cast-in part coincides with the top edge of the FFB.

2.14 Concreting the cast-in part

After concreting, the cast-in part is 225 mm above the unfinished floor (RFB) if it is positioned correctly. Due to the system, it is possible to shorten the structural element to the later floor structure or the finished floor level by up to 155 mm later.

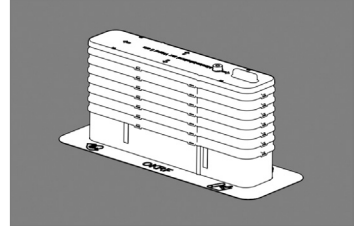

2.15 Apply tanking membranes.

Tanking membranes in the area of the feed-throughs using suitable aids. Make sure that the transition is even.

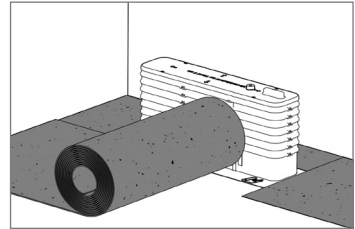

INSTALLATION NOTES

Quadro-Secura® house lead-ins

- Quadro-Secura® Nova R1
- Quadro-Secura® Nova R2
- Quadro-Secura® Nova R3
- Quadro-Secura® Nova R4

25
years
guarantee



- If it is not possible to shorten to the finished floor height for structural reasons, the shell component may protrude max. half the height of the levelling frame above the upper edge of the finished floor.

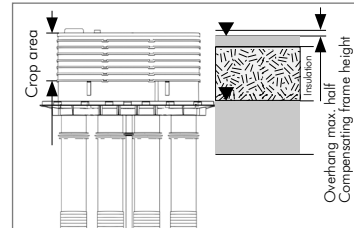

2.16 Final result

Quadro-Secura® Nova R4-R (cast-in part) set in concrete at finished floor level (FFB).

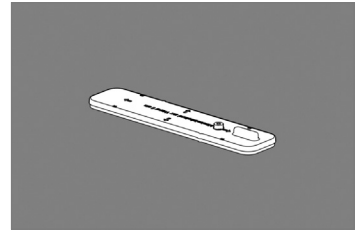

3 Mounting: Installation part Quadro-Secura® Nova R4-I

3.1 Removal of the seal cap

After concreting the Quadro-Secura® Nova R4-R (cast-in part), the seal cap can be removed from the cast-in part using the handle.

Attention!

To meet the requirements for thermal load-bearing capacity according to DVGW test guideline VP 601 point 4.8 and to maintain DVGW approval, the structural shell must be completely cast in.

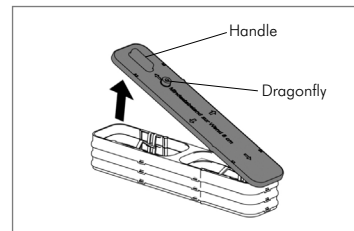

INSTALLATION NOTES

Quadro-Sicura® house lead-ins

- Quadro-Sicura® Nova R1
- Quadro-Sicura® Nova R2
- Quadro-Sicura® Nova R3
- Quadro-Sicura® Nova R4

25
years
guarantee

3.2 Compensating frame and cast-in part

The protrusion of the cast-in part is removed by taking off the individual equalising frames. To do this, grasp the tabs of the compensating frame with both hands and pull it out upwards.



If it is not possible to shorten the cast-in part to the finished floor height for structural reasons, the cast-in part may protrude a maximum of half a Compensating frame high above the upper edge of the finished floor.

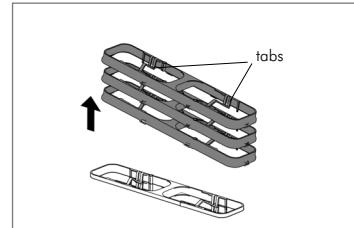

3.3 Make pipe ends slippery

Then coat the sealing rings of the pipe ends of the installation part sufficiently with self-volatilising lubricant. Before inserting the installation part, the sleeve pipes of the building shell must be greased on the inside in the insertion area. The height of the area to be greased depends on the insertion depth: minimum 70 mm, maximum 200 mm.

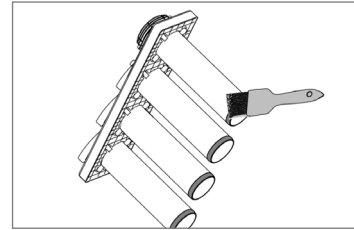

3.4 Push the installation part into the cast-in part

Insert the Quadro-Sicura® Nova R4-I installation part completely into the Quadro-Sicura® Nova R4-R cast-in part set in concrete until the flange of the installation part rests on the finished floor FFB. Then drive both nail screws into the structural member with a hammer.

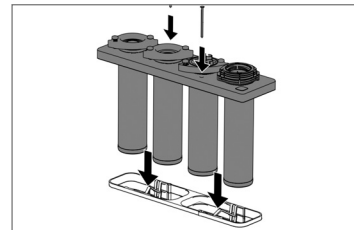

Note:

If the Quadro-Sicura® Nova R1-I is used with building sealing for gas, four nail screws must be driven into the cast-in part with a hammer.

Note:

For the installation of gas, electricity, water and telecommunications, please use the corresponding installation instructions.

INSTALLATION NOTES
Quadro-Secura® house lead-ins

- Quadro-Secura® Nova R1
- Quadro-Secura® Nova R2
- Quadro-Secura® Nova R3
- Quadro-Secura® Nova R4

25
years
guarantee

Note:

Utilities that are not occupied must remain in the as-delivered condition. Do not tighten the clamp Gas Schuck 1", VAF-Voigt 1", Energy and Water up to the anchor plate, keep a distance of 4 mm. The Gas RMA 1", Telecom and X-LWL clamps must rest on the anchor plate.

INSTALLATION PROTOCOL CHECKLIST

WORK SMARTER!



QR code scan & simply digitally fill in

NOTE

The installation protocol supports you in documenting the proper and professional installation of the Quadro-Secura® single- and multi-compartment house lead-in. It does not replace the installation instructions for the product. Please be sure to observe the separate instructions for professional installation. We also recommend that you keep sufficient pictures of the individual installation steps, as well as the Quadro-Secura® invoice and the 25-year guarantee certificate.

PLACE OF INSTALLATION

Type of building

Street/No.

Postcode/city

DOYMA-REFERENCENUMBER

Handwritten number on the sticker of the installation part of your single- and multi-compartment house lead-in.

INSTALLATION NOTES

Quadro-Sicura® house lead-ins

- Quadro-Sicura® Nova R1
- Quadro-Sicura® Nova R2
- Quadro-Sicura® Nova R3
- Quadro-Sicura® Nova R4

25
years
guarantee

INSTALLATION PROTOCOL CHECKLIST

1. PRODUCT Quadro-Sicura® Nova R1- R4

For buildings without a basement..

Which Quadro-Sicura® Nova was used?

R1 R2 R3 R4

What length of casing pipe was used:

3 m 6 m 10 m 15 m 25 m

2. PLACEMENT OF CAST-IN PART

The placement of the cast-in part is illustrated using the Quadro-Sicura® Nova R4 as an example.

Has the installation position/height been agreed with the utility company/grid operator?

Yes No

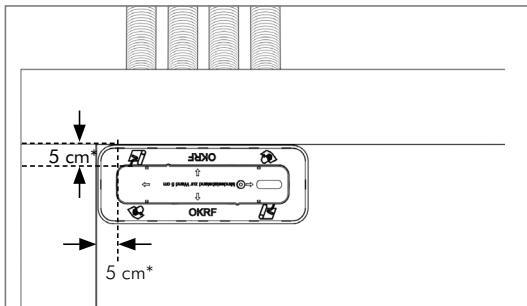

* Please coordinate the exact dimensions with your supply company..

Please also note the installation instructions.

- Quadro-Sicura® Nova R1
- Quadro-Sicura® Nova R2
- Quadro-Sicura® Nova R3
- Quadro-Sicura® Nova R4

INSTALLATION PROTOCOL CHECKLIST

3. VISUAL INSPECTION

Has the jacket pipe been fitted correctly?

Yes No

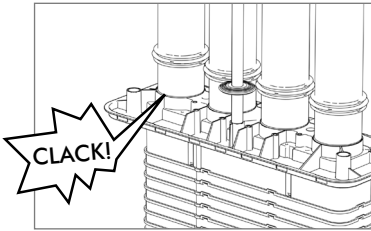

Has a visual inspection been carried out?

Yes NO

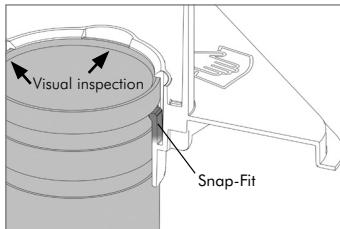

Please also note the installation instructions.

INSTALLATION NOTES
Quadro-Secura® house lead-ins

- Quadro-Secura® Nova R1
- Quadro-Secura® Nova R2
- Quadro-Secura® Nova R3
- Quadro-Secura® Nova R4

25
years
guarantee

INSTALLATION PROTOCOL CHECKLIST

4. CAST-IN PART ALIGNMENT

If the alignment of the cast-in part in terms of position and height?

Yes No

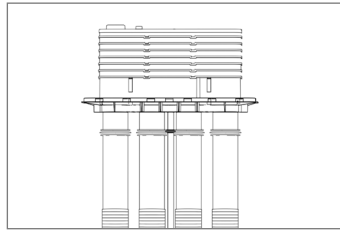
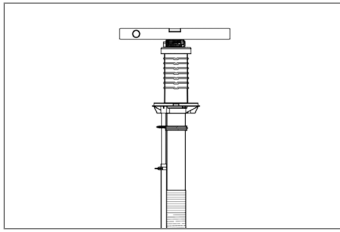

5. BENDING RADIUS/SANDING

If the bending radius was observed?

Yes No

Have the jacket pipes been professionally sanded?

Yes No

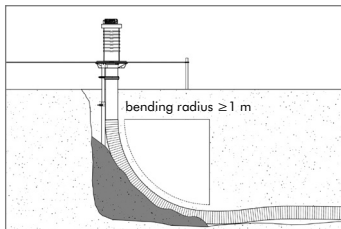

INSTALLATION PROTOCOL CHECKLIST

6. JACKET PIPES CORRECTLY EXECUTED

We recommend laying the rigid jacket pipes without extension up to the property boundary?

Yes No

We recommend laying the rigid jacket pipes without extension up to the property boundary!

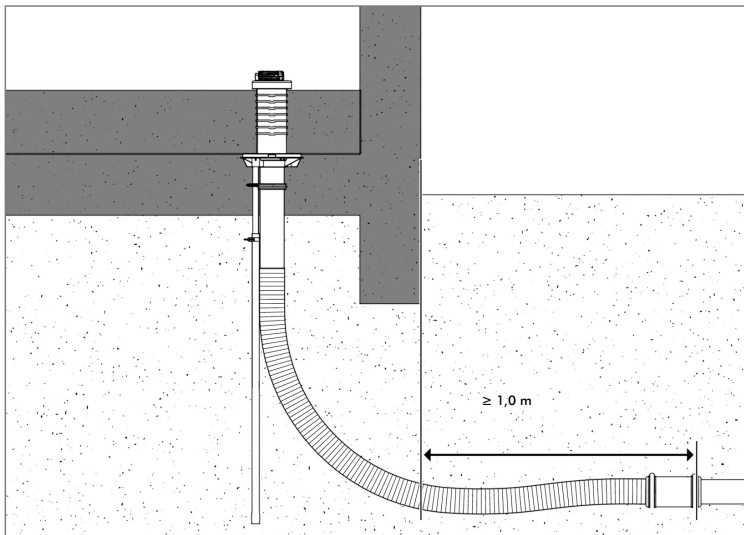

! ATTENTION!

No inspection chambers, drainage pipes or other pipes may be laid in the area of the house connection route. It is technically possible to extend the rigid protective pipes - even under the floor slab. However, please always consult your utility company before doing so.

INSTALLATION NOTES

Quadro-Secura® house lead-ins

- Quadro-Secura® Nova R1
- Quadro-Secura® Nova R2
- Quadro-Secura® Nova R3
- Quadro-Secura® Nova R4

25
years
guarantee

INSTALLATION PROTOCOL CHECKLIST

PICTURE UPLOAD - INSTALLATION PICTURES

When uploading the protocol, you have the option of uploading images for documentation purposes (files up to max. 500 KB). DOYMA does not check the data. This is not legally binding - it is a documentation service..

Confirmation of proper and professional installation in accordance with the applicable installation instructions:

Company name

Street/No.

Contact person

Postcode/town

INSTALLATION PART STORAGE

The installation part was put into/put into interim storage here:

INSTALLATION NOTES

Quadro-Secura® house lead-ins

- Quadro-Secura® Nova R1
- Quadro-Secura® Nova R2
- Quadro-Secura® Nova R3
- Quadro-Secura® Nova R4

DOYMA products are continuously being further developed. Technical changes will be performed without prior notice.
25 year warranty on all DOYMA products. **More information at www.doyma.com**

DOYMA GmbH & Co

SEALING SYSTEMS
FIRE PROTECTION SYSTEME

Industriestr. 43-57
28876 Oyten

Phon: 0 42 07/91 66-300
Fax: 0 42 07/91 66-199

www.doyma.de
info@doyma.de

25
years
guarantee

